











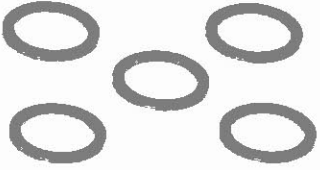

FRONT SUSPENSION (4-WHEEL) - COMMON

PARTICULAR TO RXV

<p>8069 Passenger side For G&E 2008-up RXV OEM #607411</p>  <p>NEW</p> <p>Spindle</p>	<p>8068 Drivers side For G&E 2008-up RXV OEM #607413</p>  <p>NEW</p> <p>Spindle</p>
<p>8071 For G&E 2008-up RXV OEM #620380</p>  <p>NEW</p> <p>Spindle pin bolt</p>	<p>8072 5/Pkg For G&E 2008-up RXV OEM #600549</p>  <p>NEW</p> <p>Spindle pin nut</p>
<p>8070 For G&E 2008-up RXV OEM #601920</p>  <p>NEW</p> <p>Thrust washer</p>	<p>8074 5/Pkg For G&E 2008-up RXV OEM #601709</p>  <p>NEW</p> <p>Spindle nut</p>
<p>8073 For G&E 2008-up RXV OEM #609603</p>  <p>NEW</p> <p>Front hub assembly</p>	<p>8075 For G&E 2008-up RXV OEM #12091-G3</p>  <p>NEW</p> <p>Front hub dust cover</p>
<p>8076 For G&E 2008-up RXV OEM #601340</p>  <p>NEW</p> <p>A-Arm bushing</p>	<p>8077 For G&E 2008-up RXV OEM #602085</p>  <p>NEW</p> <p>A-Arm carrier tube</p>
<p>8078 5/Pkg For G&E 2008-up RXV OEM #601754</p>  <p>NEW</p> <p>Long A-Arm bolt</p>	<p>8079 5/Pkg For G&E 2008-up RXV OEM #602415</p>  <p>NEW</p> <p>Short A-Arm bolt</p>

- Accessories
- Club Car
- Col./H/D
- EZGO
- Taylor Dunn
- Yamaha
- Misc OEMS
- Chargers
- Motors/Crits
- Electrical
- Hardware
- Solenoids
- Tires

FRONT SUSPENSION (4 WHEEL) - COMMON

PARTICULAR TO MEDALIST & TXT

10898

For G&E 2001-up
OEM #602513

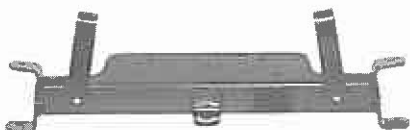

Front axle weldment

290

For G&E 1994-00 (weldment only)
with spring plates 1994-00
OEM #70539-G01 (weldment & spring plates)

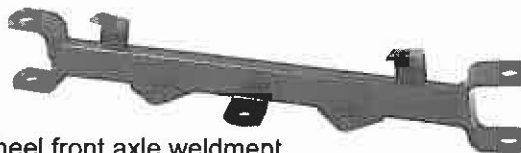

Four wheel front axle weldment

9071

For G&E 2001-up also 1994-April 98
OEM #70163-G03P

Spring retaining plate
For rectangular axle weldment



10194

For G&E May 1998-00
OEM #70540-G02P

Spring retaining plate
For square axle weldment



6802

For G&E 2001-up
OEM #70673-G03P



Spindle/hub assembly, drivers side

9626

For G&E 2001-up
OEM #70942-G01P

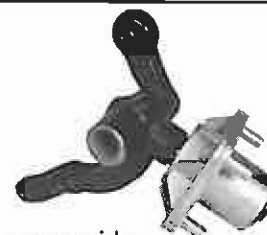

Spindle/hub assembly, passenger side

6056

OEM #70942-G02P

Passenger side

6057

OEM #70673-G02P

Drivers side

For G&E 2001-up

Shown
#6056



Spindles

6704

OEM #00560-G5



Spindle washer

6059

OEM #70221-G01

Passenger side

6060

OEM #70220-G01

Drivers side

For G&E 1994-(early)-01

Shown
#6059



Spindle and hub assembly

5623

OEM #70267-G02

Passenger side

5624

OEM #70267-G01

Drivers side

For G&E 1994-(early) 01

#5623

#5624

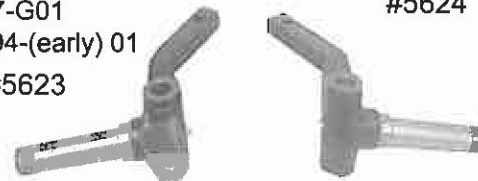

Spindles

5006

For G&E 1994-00
OEM #76418-G01



Shock absorber .
13" closed, 17" open

5030

For all shock studs



Shock bushing kit

13021

For G&E 1994-03
OEM #10194-G1



Shock bushing
2 required per shock

FRONT SUSPENSION (4 WHEEL) - COMMON

PARTICULAR TO MEDALIST & TXT

6315

For G&E 2004-up
OEM #70990-G03P



2 leaf standard front spring. 20-1/2"

11030

Heavy duty

9177

Replacement

For G&E 2001-03
OEM #70597-G03



2 leaf spring heavy duty and standard

288

Replacement

OEM #70431-G01

295

Heavy duty

OEM #70422-G01P
For G&E 1994-00



Front leaf springs

6430

OEM #70989-G03P

For G&E 2003-up



2 leaf heavy duty front spring

5581

For G&E 2001-up
OEM #00407-G6



Spindle pin bolt

5627

For G&E 2001-up
OEM #14390-G6



Spindle pin nylon lock nut

5585

For G&E 2001-up
OEM #70745-G01P



Spindle pin tube

4936

For G&E 1994-00
OEM #70327-G01



Spindle pin bolt

4906

For G&E 1994-00
OEM #70328-G01P



Spindle tube bushing

1750

20/Pkg

For G&E 1994-up
OEM #10387-G1

1/16" x 1-1/2"
spindle cotter pin



14413

For G&E 2001½-up



Front hub kit
Includes hub, bearings and seals

14412

For G&E 1976-01½



Front hub kit
Includes hub, bearings and seals

9624

For G&E 2001-up
OEM #70895-G01



Front hub with bearing races

5054

For G&E 1976-00
OEM #19932-G1



Front hub with bearing races

FRONT SUSPENSION (4 WHEEL) - COMMON

PARTICULAR TO MEDALIST & TXT

10827

For G&E all years
OEM #50892-G1



Bearing set. Includes (1)-3708 and (1)-3707

3708

For G&E all years
OEM #50892-G1 / #L-44643



Wheel bearing cone

3707

For G&E all years
OEM #50892-G1 / #L-44610



Wheel bearing race

643

For G&E 1980-00
OEM #16623-G1



King pin or spindle pin bearing

628

For G&E 1980-00
OEM #16982-G1



Spindle thrust washer

4643

For G&E 1979-up
OEM #12091-G2



Front hub dust cover

3930

For G&E all years
OEM #25146-G1



Wheel grease seal

1694

For G&E 1981-up
OEM #12093-G1

10/Pkg



Front hub and spindle nut

1688

For G&E all years
OEM #14723-G1

20/Pkg



1/2"-20 lug nut

1638

For G&E 1981-up
OEM #19862-G1

20/Pkg



1/2"-20 x 1-3/16" lug bolt

PARTICULAR TO ST350

9056

For gas (4 cycle) ST350 1996-up
OEM #70515-G01P



Drop front axle weldment standard for ST350
or use to lift Medalist or TXT 3" or 5" lift

293

For gas (4 cycle) ST350 1996-up
OEM #70515-G01



Drop front axle weldment standard for ST350
or use to lift Medalist or TXT standard lift

4969

Passenger side

OEM #70534-G03

4976

Drivers side

OEM #70535-G03

For gas (4 cycle) ST350 1996-up

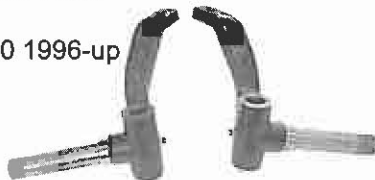

Spindles for ST350

295

For gas 1996-03 ST350 Workhorse™

OEM #70422-G01P



Front leaf spring (heavy duty)

**FRONT SUSPENSION (4 WHEEL) - COMMON
PARTICULAR TO ST350**

6777

For G&E 1992-up
OEM #70904-G04



Tie rod assembly for ST350/480/Sport with new style tie rod end

4814

For gas (4 cycle) ST350 1996-up
OEM #01040-G01



Spindle pin bolt

4815

20/Pkg

For gas (4 cycle) ST350 1996-up
OEM #00571-G5



Spindle pin washer

PARTICULAR TO ST 4X4

6075

For gas (4 cycle) 2004-up



Front strut

PARTICULAR TO 4 WHEEL MARATHON

281

For G&E 1989-94 pre Medalist
OEM #23918-G2P



Four wheel front axle weldment

5640

Passenger side

OEM #25836-G01

5641

Drivers side

OEM #25837-G01

For G&E 1990-94 pre Medalist

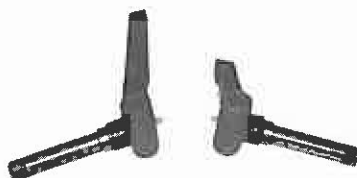

Spindle assemblies

9521

For G&E 1989-94

OEM #24065-G1



3 leaf heavy duty
front spring. 16-3/4"

11014

Standard

277

Premium

For G&E 1989-94 pre Medalist
OEM #24025-G1



17" four wheel front 2 leaf spring

FRONT SUSPENSION (4 WHEEL) - COMMON PARTICULAR TO 4 WHEEL MARATHON

289

For G&E 1985-88
OEM #19385-G1



Four wheel front axle weldment

6706

For G&E 1994-down
OEM #15023-G2

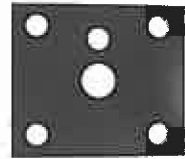

Spring retaining plate

11033

Standard

275

Premium

For G&E 1979-88
OEM #15040-G1



Four wheel front 2 leaf spring. 19"

9504

For G&E 1979-88
OEM #17989-G1



3 leaf heavy duty front spring
18-3/8"

9488

For electric 1976-78
OEM #15086-G1



3 leaf spring. 24-1/4"

5000

For G&E 1970-94 pre Medalist
OEM #76419-G01



Front shock absorber.
13" closed/17" open

5030

For all shock studs



Shock bushing kit

286

For G&E 1990-94 pre Medalist
OEM #25177-G2



King pin

13021

For G&E 1985-03
OEM #10194-G1



NEW

Shock bushing
2 required per shock

3951

For G&E 1980-94 pre Medalist
OEM #16626-G1



King pin
and spindle pin seal

14436

For G&E 1989-94 Marathon
OEM #00879-G7



NEW

2" king pin washer

14412

For G&E 1976-01-1/2



NEW

Front hub kit
Includes hub, bearings and seals

5054

For G&E 1976-01-1/2
OEM #19932-G1



Front hub with bearing races

10827

For G&E all years
OEM #50892-G1

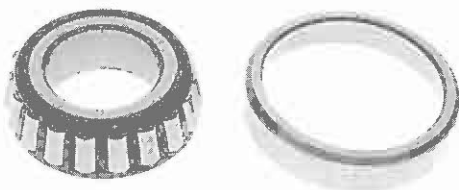

Bearing set. Includes (1)-3708 and (1)-3707

3708

For G&E all years
OEM #50892-G1 / #L-44643



Wheel bearing cone







3707

For G&E all years
OEM #50892-G1 / #L-44610



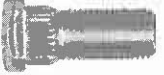

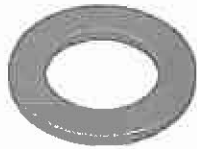





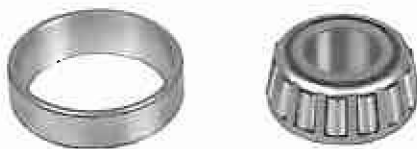

Wheel bearing race

FRONT SUSPENSION (4 WHEEL) - COMMON
PARTICULAR TO 4 WHEEL MARATHON

<p>3930 For G&E all years OEM #25146-G1</p>  <p>Wheel grease seal</p>	<p>1694 10/Pkg For G&E 1981-up OEM #12093-G1</p>  <p>Front hub and spindle nut</p>	<p>1688 20/Pkg For G&E all years OEM #14723-G1</p>  <p>1/2"-20 lug nut</p> <hr/> <p>1638 20/Pkg For G&E 1981-up OEM #19862-G1</p>  <p>1/2"-20 x 1-3/16" lug bolt</p>
<p>643 For G&E 1980-00 OEM #16623-G1</p>  <p>King pin or spindle pin bearing</p>	<p>628 For G&E 1980-00 OEM #16982-G1</p>  <p>Spindle thrust washer</p>	<p>4643 For G&E 1979-up OEM #12091-G2</p>  <p>Front hub dust cover</p>

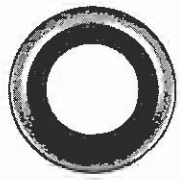
3 WHEEL FRONT SUSPENSION

<p>5511 For G&E 3 wheel 1982-90 OEM #19796-G1</p>  <p>3 wheel front shock and spring assembly</p>	<p>3717 For G&E 3 wheel 1965-93 OEM #11103-G1 / #LM-48548L</p>  <p>Front stem bearing</p>	<p>3718 For G&E 3 wheel 1965-93 OEM #11103-G1 / #LM-48510</p>  <p>Fork stem bearing race</p>	
<p>282 For G&E 3 wheel 1984-93 OEM #10223-G5</p>  <p>12-1/2" 3 wheel front axle</p>	<p>3751 For G&E 3 wheel all years OEM #50908-G1</p>  <p>Wheel bearings 1-#LM-11949, 1-#LM-11910</p>	<p>3701 For G&E 3 wheel all years OEM #50908-G1</p>  <p>Wheel bearings 1-#LM11949, 1-#LM-11910</p>	
<p>3901 For G&E 3 wheel all years OEM #19471-G1</p>  <p>3 wheel hub grease seal</p>	<p>3732 For G&E 3 wheel all years OEM #11750-G1</p>  <p>Timken wheel bearing cone 1-#LM-11949</p>	<p>3931 For G&E 3 wheel all years OEM #19471-G1</p>  <p>3 wheel hub grease seal</p>	<p>3731 For G&E 3 wheel all years OEM #11752-G1</p>  <p>Wheel bearing race 1-#LM-11910</p>

REAR SUSPENSION - COMMON

PARTICULAR TO RXV

8093

For G&E 2008-up RXV
OEM #603498



**TOO NEW
FOR PHOTO**

Standard rear spring

8094

For G&E 2008-up RXV
OEM #604494



Heavy duty rear spring

8096

For G&E 2008-up RXV
OEM #603495



Spring plate

8095

For G&E 2008-up RXV
OEM #603415



U-Bolt

8098

For G&E 2008-up RXV
OEM #620161

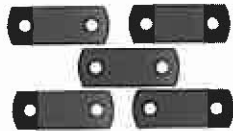

Rear spring bushing spacer

8097

For electric 2008-up RXV
OEM #620160



Large front bushing for rear leaf spring

8161

For gas 2008-up RXV
OEM #605684



Large front bushing for rear leaf spring

8099

For G&E 2008-up RXV
OEM #603648



Rear spring shackle plate

8100

For G&E 2008-up RXV
OEM #603637



Rear shock

8101

For G&E 2008-up RXV
OEM #601414

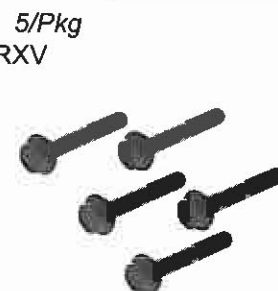

Rear shock bolt



5/Pkg

REAR SUSPENSION - COMMON

MEDALIST & TXT REAR SUSPENSION PARTS

10983 Standard

291 Premium
For G&E 1994-up
OEM #603109



Standard 2 leaf rear spring

833

For G&E 1994-up
OEM #72029-G01

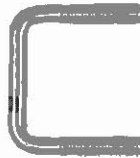

Standard U bolt
Uses #1653 nut

6054

For gas 1994-up
OEM #72037-G01



ISO mount cap
for rear spring

10964 Standard

292 Premium
For G&E 1994-up 4 Caddy & TXT
OEM #74207-G03P



Heavy duty 4 leaf rear spring

838

For G&E 1994-up 4 Caddy
OEM #72618-G01



Heavy duty U bolt

6179

For gas 1994-up
OEM #72117-G01



ISO mount bushing

6425

For G&E

**TOO NEW
FOR PHOTO**

Rear spring bushing kit.
Includes (8)-3132 and (4)-3133

3133

10/Pkg

For G&E 1994-up
OEM #70289-G02



2-3/8" bushing spacer

3132

For G&E 1994-up
OEM #70291-G01



Rear leaf spring bushing
8 required per car

6178

For electric 1994-up
OEM #70290-G01P



Rear spring shackle plate

6424

For G&E 1996-up TXT
OEM #00665-G9



Rear shackle bolt. 3/8"-16x3-1/2" long

5006

For G&E 1994-up
OEM #76418-G01



Rear shock absorber

5030

For all shock studs

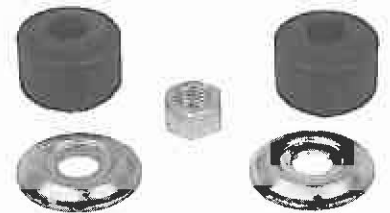

Shock bushing kit

PARTICULAR TO ST 4X4

6409

For gas 2004-up
OEM #73802-G01P



Rear leaf spring

6410

For gas 2004-up
OEM #73900-G01



U bolt

REAR SUSPENSION - COMMON

PARTICULAR TO ST350

10964 Standard
292 Premium
 For gas (4 cycle) ST350 1996-up
 OEM #74207-G03P



Heavy duty 4 leaf spring. 27" long

3132
 For gas (4 cycle) ST350 1996-up
 OEM #70291-G01



Rear leaf spring bushing

3133 10/Pkg
 For gas (4 cycle) ST350 1996-up
 OEM #70289-G02



2-3/8" bushing spacer

5620
 For gas ST350 & ST4x4 1996-up
 OEM #70492-G01



Rear stop bumper

838
 For gas (4 cycle) ST350 1996-up
 OEM #72618-G01

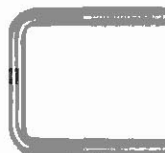

Heavy duty U bolt

5010
 For gas (4 cycle) ST350 1996-up
 OEM #70509-G01



Shock boot dust cover

MARATHON REAR SUSPENSION PARTS

10955 Standard
279 Premium
 For electric 1975-94 pre Medalist
 OEM #20398-G1



Standard 3 leaf rear spring

870
 For electric 1965-94
 OEM #13716-G2



Standard U bolt
 for 3 leaf spring, Uses #1653 nut

5635
 For electric 1986-1/2-94
 pre Medalist
 OEM #27540-G01

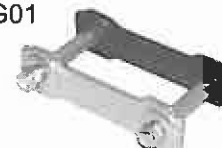

Rear spring shackle kit

10969 Standard
280 Premium
 For electric 1975-94 (4 passenger)
 OEM #11645-G2



Heavy duty 5 leaf rear spring

822
 For electric 1975-94
 OEM #13716-G2



Heavy duty U bolt
 for 5 leaf spring. Uses #1653 nut

6708
 For electric 1975-94
 OEM #15727-G1



Shoulder bolt. 3/8"-16x2-3/8"

5009
 For electric 1986-1/2-94 pre Medalist
 OEM #20278-G1

5005
 For electric 1979-86-1/2
 OEM #21781-G1



Rear shock absorber

5001
 For gas 1979-94 pre Medalist
 OEM #21780-G1



Rear shock absorber

3078
 For electric 1965-94
 OEM #20098-G1



Rear leaf spring bushing

5030
 For all shock studs



Shock bushing kit

REAR AXLES & PARTS - COMMON

SPLINED REAR AXLES (ELECTRIC & 2 CYCLE)



Rear splined axle

8092 Passenger side rear axle
OEM #620341

8091 Drivers side rear axle
OEM #620337



Above axles for electric 2008-up RXV

233 Passenger side rear axle
16-3/4" long OEM #20377-G12

242 Drivers side rear axle
23-7/8" long OEM #20377-G11

Above axles for electric 1994-up

237 Passenger side rear axle
17-3/4" long OEM #20377-G4

236 Drivers side rear axle
24-5/8" long OEM #20377-G3

Above axles for electric 1988-94 pre Medalist

238 Passenger side rear axle
20-1/4" long OEM #20377-G7

239 Drivers side rear axle
22" long OEM #20377-G8

Above axles for gas (2 cycle) 1989-93

234 Passenger side rear axle
17-1/4" long OEM #20377-G1

235 Drivers side rear axle
25-1/8" long OEM #20377-G2

Above axles for electric 1986-87

232 Passenger side rear axle
25" long OEM #17781-G1

233 Drivers side rear axle
16-3/4" long OEM #20377-G12

Above axles for gas 1983-88

230 Passenger side rear axle
20-3/4" long OEM #17783-G1

231 Drivers side rear axle
21-1/2" long OEM #17784-G1

Above axles for electric 1983-85

REAR AXLES & PARTS - COMMON

SPLINED REAR AXLES (ELECTRIC & 2 CYCLE)

8087

For electric 2008-up RXV
OEM #604112

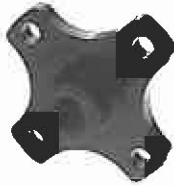

Rear wheel hub

3870

For electric 1978-up
also gas (2 cycle) 1978-93
OEM #15112-G1 / #6004LL



Rear axle bearing

3936

For electric 1978-up
also gas (2 cycle) 1978-93
OEM #15114-G1



Outer rear axle seal

4840

10/Pkg

For electric 1978-up
also gas (2 cycle) 1978-93
OEM #15113-G1



Snap ring

5644

For E-Z-GO electric 1994-97
OEM #24939-G1P



Rear spindle adapter cap

1689

20/Pkg

For electric 1976-up
also gas (2 cycle) 1978-93
OEM #15483-G1



Slotted nut

GAS (4 CYCLE) REAR AXLE PARTS

8159

Passenger side rear axle

OEM #607988

8158

Drivers side rear axle

OEM #607987



Above axles for gas 2008-up RXV

5637

Passenger side rear axle

19-1/2" long OEM #72057-G01

5638

Drivers side rear axle

21-5/8 long OEM #72056-G01

Above axles for gas (4 cycle) 1994-02

5633

Drivers side rear axle

22-3/8" long OEM #26809-G01

5634

Passenger side rear axle

20-3/8" long OEM #26810-G01

Above axles for gas (4 cycle) 1991-94 Marathon



3859

For gas (4 cycle) 1991-up
OEM #26811-G01 / #6205LL

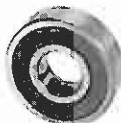

Rear axle bearing

3998

For gas (4 cycle) 1991-up
OEM #26766-G01



Rear axle seal

14469

For gas (4 cycle) 1991-up
OEM #26814-G01



Snap ring

5645

For gas (4 cycle) 1994-97,
1996-03 ST350
OEM #24939-G2P



Rear spindle adapter cap

8160

For gas 2008-up RXV
OEM #606403



TOO NEW FOR PHOTO

Rear axle nut

6818

For gas (4 cycle) 1991-up
OEM #00518-G8

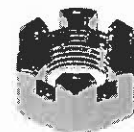

Axle nut

E-Z-GO

REAR AXLES & PARTS - COMMON

KEYED REAR AXLES & PARTS

240 Passenger side rear axle kit
20-7/8" long
OEM #15555-G1

241 Drivers side rear axle kit
21-1/2" long
OEM #15556-G1
For electric 1977-81



*Kit contains axle, key, cotter pin, nut and washer

3870
For electric 1978-up
also gas (2 cycle) 1978-93
OEM #15112-G1 / #6004LL



Rear axle bearing

3936
For electric 1978-up
also gas (2 cycle) 1978-93
OEM #15114-G1



Outer rear axle seal

4840 10/Pkg
For electric 1978-up
also gas (2 cycle) 1978-93
OEM #15113-G1



Snap ring

1689 20/Pkg
For electric 1976-up
also gas (2 cycle) 1978-93
OEM #15483-G1



Slotted nut

9481
For G&E 1976-81
OEM #15484-G1



Square key. 1/4" x 1/4" x 1-1/2"

TERREL REAR AXLE PARTS

3872
For E-Z-GO/Pargo with Terrel axles
OEM #23519-G1 / #6005LL



Rear axle bearing

3938
For E-Z-GO/Pargo with Terrel axles
OEM #2633

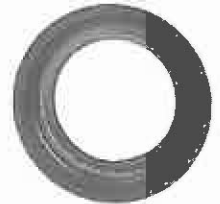

Rear axle seal

OTHER REAR AXLE BEARINGS

3709
For some pre 1978 cars
OEM #13084-G1 / #U-199, U-160L



Rear axle bearing

3704
For some pre 1978 cars
OEM #50541-G1 / #15575T



Rear axle bearing cone

3703
For some pre 1978 cars
OEM #50542-G1 / #15520



Rear axle cup

REAR AXLES & PARTS - COMMON

OTHER REAR AXLE SEALS

3976

For electric 1976-79
OEM #601066



Inner rear axle seal

3909

For G&E 1965-75
OEM #50540-G1



Inner rear axle seal, thin

3985

For G&E 1965-72
OEM #50545-G1



Outer rear axle seal

DIFFERENTIAL & TRANSAXLE PARTS - COMMON

ELECTRIC INPUT SHAFTS & PARTS

4834

For electric 1991-94
also 1994-up with 21 tooth gear
OEM #26926-G01



Input shaft kit. Includes shaft, bearings, o'rings and c-clips

5062

For electric 1988-90
also 1994-up with 22 tooth gear
OEM #23501-G3



Input shaft kit includes shaft, bearings, o'rings and c-clip

3250

For electric 1988-96 with GE motor
OEM #750COUPLING



Electric motor coupler (19 spline)

5660

For gas (4 cycle) 1991-04
OEM #26772-G01



Differential oil filler plug, yellow

3131

For electric 1989-up
OEM #24261-G1

10/Pkg



Spline bumper G.E. / Advanced

3872

For electric 1988-up
OEM #23519-G1/#6005LL

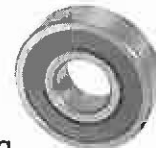

Motor side input shaft bearing

3854

For electric 1988-up
OEM #23520-G1 / #6203



Motor side input shaft bearing

3878

For electric 1988-up
OEM #17473-G1/6007



Output gear bearing

3869

For electric 1988-up
OEM #23521-G1/#6303DU



Freeze plug intermediate gear bearing

6156

OEM #601064



Dana electric differential

GAS (4 CYCLE) TRANSAXLE PARTS

3859

For gas (4 cycle) 1991-up
OEM #73120-G07 / #6205LL



Sealed transaxle bearing

3854

For gas (4 cycle) 1991-up
OEM #23520-G1 / #6203



Open transaxle bearing

3979

For gas (4 cycle) 1991-up
OEM #26761-G01



Input shaft seal

3822

For gas (4 cycle) 1991-up
OEM #26783-G01 / #6205



Open transaxle bearing

3823

For gas (4 cycle) 1991-up
OEM #26806-G01 / #6008



Open transaxle bearing

3855

For gas (4 cycle) 1991-up
OEM #26785-G01 / #6204



Open transaxle bearing

DIFFERENTIAL & TRANSAXLE PARTS - COMMON

OTHER DIFFERENTIAL PARTS

6177

For electric 1988-up
OEM #72763-G02



Differential guard, electric

6156

OEM #601064



Freeze plug,
Dana electric differential

3716

OEM #15056-G1 /
#LM-48510, #LM-48548



Differential bearing

3935

For electric 1983-87
also gas 1983-86-1/2
OEM #14113-G1



Pinion bearing seal

4729

For G&E 1977-up Dana rear
OEM #15054-G1

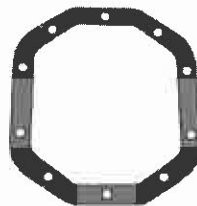

Differential cover gasket

4765

For G&E 1972-77
OEM #13977-G1

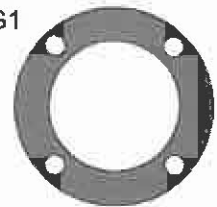

Rear bearing retainer gasket

6392

OEM #28610-G01



Differential fill plug

6728

OEM #15053-G1



Differential fill plug

9524

For G&E 1988-up
OEM #24627-G1

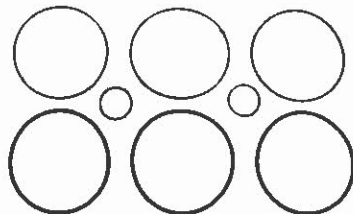

O ring seal kit

9513

For electric 1986-1/2-up
OEM #23530-G1

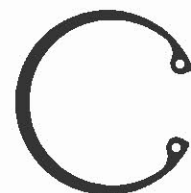

Input shaft retaining ring

TERREL DIFFERENTIAL PARTS

3822

For E-Z-GO/Pargo with Terrel axles
OEM #51051-G1 / #6205



Drivers side input shaft bearing

4746

For E-Z-GO/Pargo with Terrel axles
OEM #3148

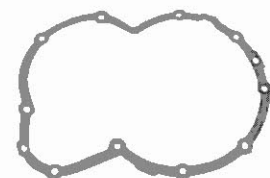

Differential case gasket

SHOCKS - COMMON

FRONT SHOCKS (4 WHEEL)

5006

For G&E 1994-early 01
OEM #76418-G01



Front shock absorber

5000

For G&E 2002-up also
1970-94 pre Medalist
OEM #76419-G01



Front shock absorber
13" closed, 17" open

5030

For all shock studs



Shock bushing kit

FRONT SHOCK (3 WHEEL)

5511

For G&E 3 wheel 1982-90
OEM #19796-G1



3 wheel front shock and spring assembly

REAR SHOCKS

8100

For G&E 2008-up RXV
OEM #603637



Rear shock

5006

For G&E 1994-up
OEM #76418-G01



Rear shock absorber

5009

For electric 1986-1/2-94 pre Medalist
OEM #20278-G1

5005

For electric 1979-86-1/2
OEM #21781-G1



Rear shock absorber

5001

For gas 1979-94 pre Medalist
OEM #21780-G1



Rear shock absorber

5030

For all shock studs

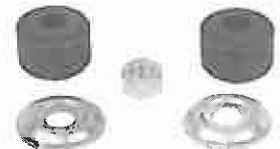

Shock bushing kit

STEERING GROUP - COMMON

STEERING WHEELS

SEE MORE GRANT STEERING WHEELS IN ACCESSORIES SECTION

9632

For G&E 2000-up
OEM #71948-G01



Steering wheel

9633

For G&E 2000-up
OEM #71950-G01



Scorecard holder with clip
Used with #9632 steering wheel

5546

For G&E 2000-up also 1996-up ST350
OEM #602979



Steering wheel only, new style

6865

For G&E 1983-00



New style steering wheel
and scorecard holder. Replaces #4669

4671

OEM #27102-G01



Scorecard holder only

4672

OEM #23225-G1



Steering wheel hub only

5547

For G&E 2000-up also
1996-00 ST350
OEM #71147-G01



Cover only

4632

For G&E 1965-82
OEM #16565-G1

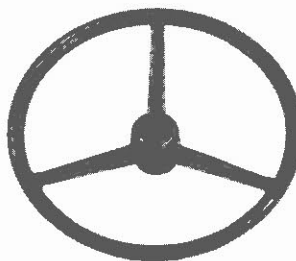

Steering wheel with center cap

4631

For #4632



Steering wheel center cap

5548

For G&E 2000-up also
1996-up ST350
OEM #71949-G01



Hub only

STEERING GROUP - COMMON

UPPER STEERING & SCORECARD

13039

For G&E 1994-06 Medalist & TXT
OEM #71047-G01



Decal for steering wheel

4308

10/Pkg

For G&E 1965-82
OEM #12186-G1

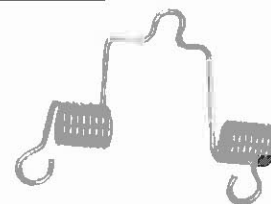

Scorecard holder spring

638

For G&E 1976-up
OEM #17161-G1



Steering tube bushing

646

For G&E 1965-70
OEM #31772-G1



Steering tube bushing

4749

For G&E 1965-70
OEM #16772-G1



Steering tube dust cover gasket

STEERING COLUMNS

8085

For G&E 2008-up RXV
OEM #600333



Steering column

6063

For G&E 2001-up
OEM #70610-G03



Steering column, 4 bolt design

6774

For G&E 1994-01
OEM #70360-G01

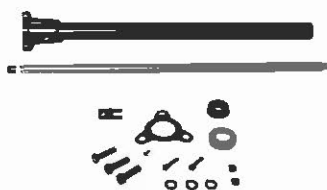

Steering shaft/column kit
4 bolt design

5589

For G&E 2001-up
OEM #28569-G01



Steering column bushing

6722

For G&E 1994-up
OEM #14322-G3



Steering shaft assembly, 26-1/4" long

6813

For G&E 2001-up
OEM #70607-G01



Steering shaft

10906

For G&E 1994-95 Medalist
to serial #901143
OEM #70222-G02



Steering column, 26" long

5636

For G&E 1995-00 Medalist & TXT
from serial #901144, 25-1/4" total length
OEM #70721-G01



Steering column, 3 bolt design

5632

For G&E 1973-94
OEM #70722-G01



Steering column, 24" long

6721

For G&E 1994-down
OEM #17163-G1



Steering shaft assembly, 26-1/2" long

STEERING GROUP - COMMON

LOWER STEERING RXV

8080

For G&E 2008-up RXV
OEM #601500



Steering box assembly

8082

For G&E 2008-up RXV
OEM #604614



Steering rod end

8084

For G&E 2008-up RXV
OEM #602020

5/Pkg

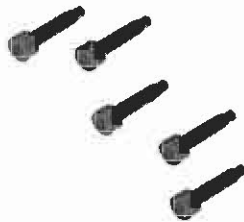

Steering box mounting screw

8083

For G&E 2008-up RXV
OEM #604615



Rack bellows

8081

For G&E 2008-up RXV
OEM #603865



Inner steering rod

8086

For G&E 2008-up RXV
OEM #604613



Steering yoke assembly

STEERING GROUP - COMMON

LOWER STEERING MEDALIST & TXT (2000-Newer)

5559
For G&E 2001-up
OEM #70964-G01

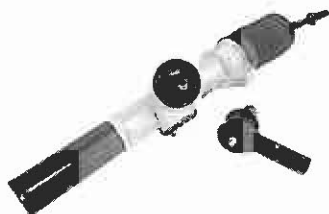

Steering box assembly

6064
For G&E 2001-up
OEM #70580-G01



Intermediate steering shaft

5580
For G&E 2001-up
OEM #70876-G02



9625
Tie rod only



Tie rod assembly

6776
For G&E 1994-01
OEM #70904-G02



Tie rod assembly

5068
For G&E 2001-up
Not available from OEM



Steering rack only. 1" x12-3/8"L

5069
For G&E 2001-up
OEM #70961-G01



Rack bellow

9627
For G&E 2000-up
OEM #70994-G01



Steel template for installing updated version of #5559 steering box into early axle weldments

5593
For G&E 2001-up
OEM #70695-G01



Rack ball joint

5594
For G&E 2001-up
OEM #70694-G01



Inner rack extension

5578
For G&E 2001-up
OEM #70902-G02



Tie rod end (right hand thread)

5579
For G&E 2001-up
OEM #70902-G01



Tie rod end (left hand thread)

LOWER STEERING MEDALIST & TXT (1994-00)

5540
For G&E 1994-00
OEM #70323-G02

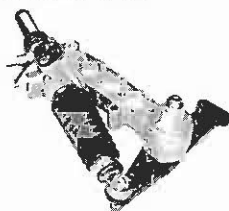

Steering box assembly

5526
For G&E 1994-00
OEM #75364-G01



Steering housing only

5533
For G&E 1994-00
OEM #70185-G01



Large flanged steering bearing

STEERING GROUP - COMMON

LOWER STEERING MEDALIST & TXT (1994-00)

5066

For G&E 1994-00
OEM #70718-G01



Steering rack only

5621

For G&E 1994-early 01
OEM #70192-G01



Outer rack ball end

5642

For G&E 1994-01
OEM #70183-G01

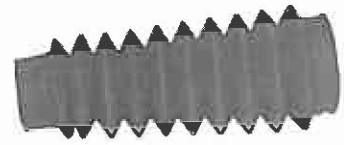

Rack bellows

4963

For G&E 1994-00
OEM #70074-G01

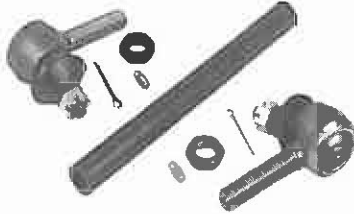

Tie rod assembly

3135

For G&E 1994-00
OEM #70297-G01



Steering pinion gear

5629

For G&E 1994-early 01
OEM #70223-G01

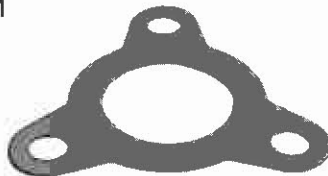

Steering column gasket

5664

For G&E 1994-00
OEM #70724-G01

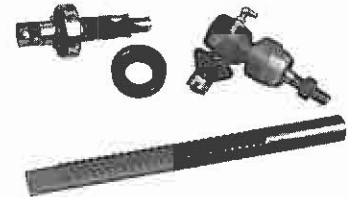

Steering repair kit

5661

For G&E 1994-01 Medalist/TXT
OEM #70041-G01



Steering rack cover

3870

For G&E 1994-00
OEM #15112-G1 / #6004LL



Steering pinion bearing

4843

For G&E 1994-00
OEM #70190-G01

20/Pkg



External steering retainer clip

LOWER STEERING ST350

4946

For gas (4 cycle) ST350 1996-02
OEM #70904-G04

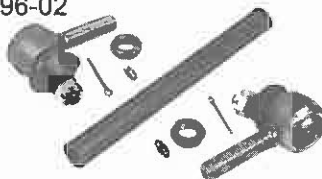

Tie rod assembly

4923

For gas (4 cycle) ST350 1996-02
OEM #70583-G05



Tie rod only

5578

For G&E 2001-up
OEM #70902-G02



Tie rod end (right hand thread)

5579

For G&E 2001-up
OEM #70902-G01



Tie rod end (left hand thread)

STEERING GROUP - COMMON

LOWER STEERING MARATHON (1994 & Prior)

5508

For 1971-94 pre Medalist
OEM #13097-G1



Steering housing only

5643

For G&E 1989-94
OEM #23929-G2



Idler arm

5033

For G&E 1989-93 4 wheel
OEM #16417-G2

5048

For G&E 1979-88 4 wheel
OEM #16417-G1

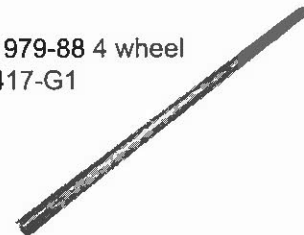

Idler shaft

262

For G&E 1971-94 Marathon
OEM #15407-G1

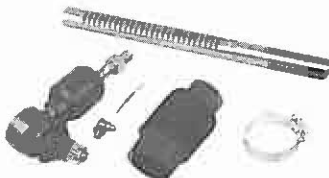

Rack and rod assembly

649

For G&E 1970-94 Marathon
OEM #23279-G1



Steering reduction gear

266

For G&E 1971-94 pre Medalist
OEM #30351-G1



Ball joint at end of rack and rod. Includes hardware

265

For G&E 1971-94 Marathon
OEM #17617-G1



Rack bellows

260

Right thread
OEM #27205-G02

261

Left thread
OEM #27205-G01
For G&E 1965-94
pre Medalist



Tie rod end

263

For G&E 1970-94 Marathon
OEM #70904-G03

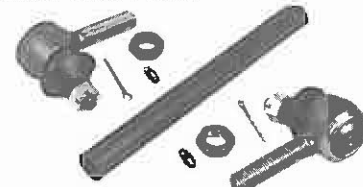

4 wheel tie rod assembly (short)

264

For G&E 1970-94 Marathon
(except 1989)
OEM #27364-G01



4 wheel tie rod assembly with tow pin

629

For G&E 1981-94 Marathon
OEM #15012-G1



Brass idler flange bushing

3799

For old worm gear steering shafts
OEM #5575

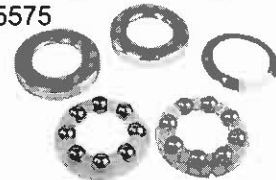

Steering ball and cup retaining kit

5626

For G&E 1973-94 pre Medalist
OEM #19154-G1

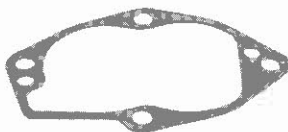

Steering column gasket

5632

For G&E 1973-94 Marathon
OEM #70722-G01



Steering column, Marathon

6144

For G&E 1973-94 Marathon
OEM #51294-G1



Wave washer, steering

STEERING GROUP - COMMON

LOWER STEERING MARATHON (1994 & Prior)

6724

For G&E 1971-94
OEM #19152-G1



Steering column assembly

6727

For G&E 1971-94
OEM #13570-G1



Steering housing rack end cover